



GaAs InGaP HBT MMIC 1 WATT POWER AMPLIFIER, 5.1 - 5.9 GHz

Typical Applications

The HMC408LP3 / HMC408LP3E is ideal for:

- 802.11a & HiperLAN WLAN
- UNII & Point-to-Point / Multi-Point Radios
- Access Point Radios

Features

- Gain: 20 dB
- Saturated Power: +32.5 dBm @ 27% PAE
- Single Supply Voltage: +5V
- Power Down Capability
- 3x3 mm Leadless SMT Package

Functional Diagram

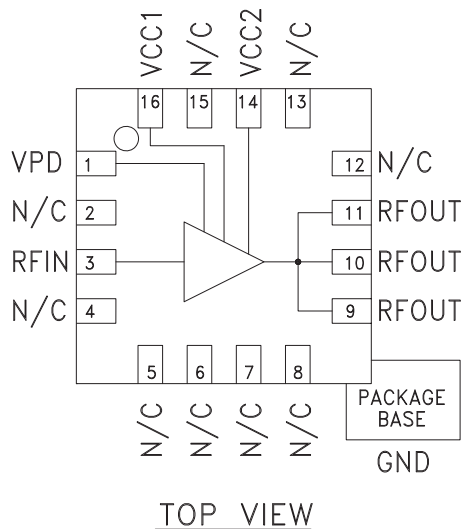

General Description

The HMC408LP3 & HMC408LP3E are 5.1 - 5.9 GHz high efficiency GaAs InGaP Heterojunction Bipolar Transistor (HBT) Power Amplifier MMICs which offer +30 dBm P1dB. The amplifier provides 20 dB of gain, +32.5 dBm of saturated power, and 27% PAE from a +5V supply voltage. The input is internally matched to 50 Ohms while the output requires a minimum of external components. Vpd can be used for full power down or RF output power/current control. The amplifier is packaged in a low cost, 3x3 mm leadless surface mount package with an exposed base for improved RF and thermal performance.

Electrical Specifications, $T_A = +25^\circ C$, $V_s = 5V$, $V_{pd} = 5V$

| Parameter | Min. | Typ. | Max. | Min. | Typ. | Max. | Units |
|--|----------------------------|-----------|-------------|-----------|-------------|-------|------------|
| Frequency Range | | 5.7 - 5.9 | | 5.1 - 5.9 | | | GHz |
| Gain | 17 | 20 | | 17 | 20 | | dB |
| Gain Variation Over Temperature | | 0.045 | 0.055 | | 0.045 | 0.055 | dB/°C |
| Input Return Loss | | 8 | | | 8 | | dB |
| Output Return Loss* | | 14 | | | 6 | | dB |
| Output Power for 1 dB Compression (P1dB) | Icq= 750 mA Icq= 500 mA | 27 | 30 27 | 24 | 27 23 | | dBm |
| Saturated Output Power (Psat) | | | 32.5 | | 31 | | dBm |
| Output Third Order Intercept (IP3) | | 40 | 43 | 36 | 39 | | dBm |
| Harmonics, Pout= 30 dBm, F= 5.8 GHz | 2 fo 3 fo | | -50 -90 | | -50 -90 | | dBc dBc |
| Noise Figure | | | 6 | | 6 | | dB |
| Supply Current (Icq) | Vpd= 0V/5V | | 0.002 / 750 | | 0.002 / 750 | | mA |
| Control Current (Ipd) | Vpd= 5V | | 14 | | 14 | | mA |
| Switching Speed | tOn, tOff | | 50 | | 50 | | ns |

* Output match optimized for 5.7 - 5.9 GHz operation. See Application Circuit herein.

Information furnished by Analog Devices is believed to be accurate and reliable. However, no responsibility is assumed by Analog Devices for its use, nor for any infringements of patents or other rights of third parties that may result from its use. Specifications subject to change without notice. No license is granted by implication or otherwise under any patent or patent rights of Analog Devices. Trademarks and registered trademarks are the property of their respective owners.

For price, delivery, and to place orders: Analog Devices, Inc., One Technology Way, P.O. Box 9106, Norwood, MA 02062-9106 Phone: 781-329-4700 • Order online at www.analog.com Application Support: Phone: 1-800-ANALOG-D



GaAs InGaP HBT MMIC 1 WATT POWER AMPLIFIER, 5.1 - 5.9 GHz

Broadband Gain & Return Loss

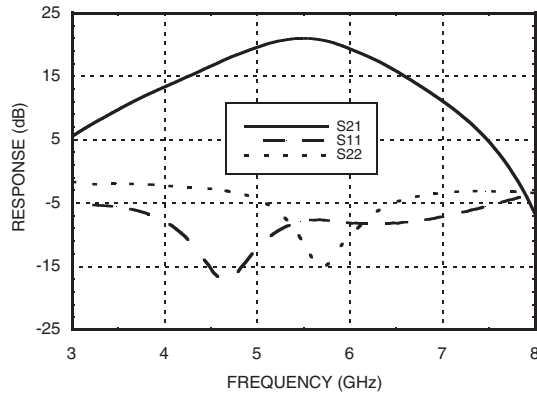

Gain vs. Temperature

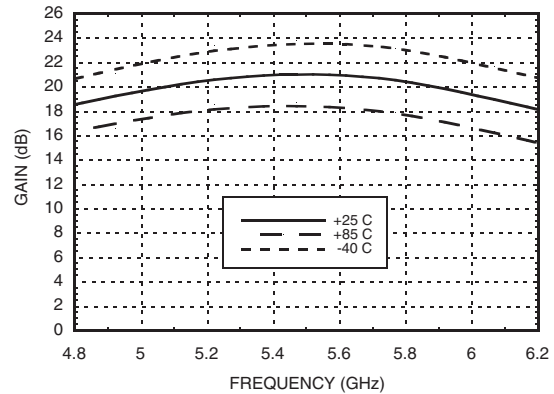

Input Return Loss vs. Temperature

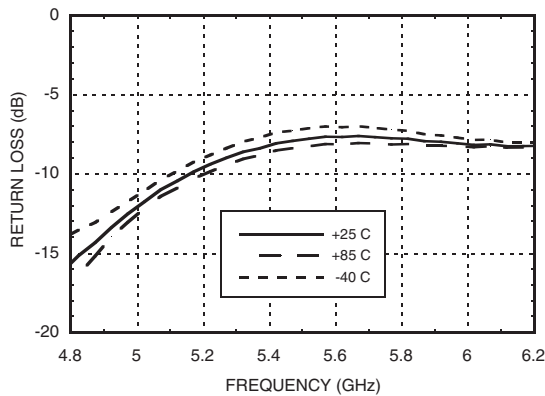

Output Return Loss vs. Temperature*

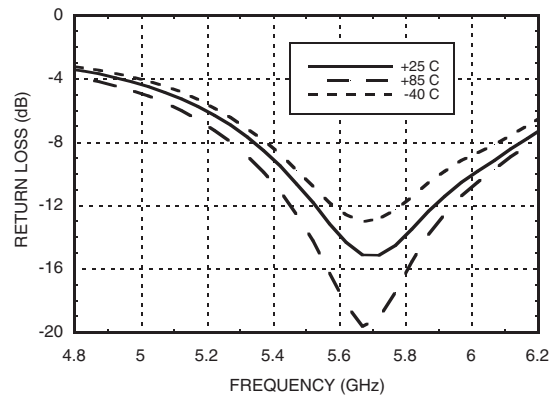

P1dB vs. Temperature

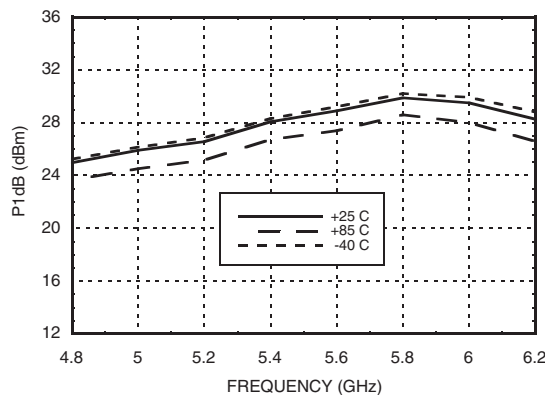

Psat vs. Temperature

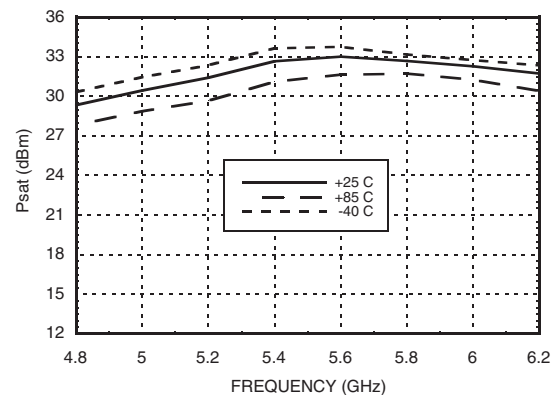

* Output match optimized for 5.7 - 5.9 GHz.

Information furnished by Analog Devices is believed to be accurate and reliable. However, no responsibility is assumed by Analog Devices for its use, nor for any infringements of patents or other rights of third parties that may result from its use. Specifications subject to change without notice. No license is granted by implication or otherwise under any patent or patent rights of Analog Devices. Trademarks and registered trademarks are the property of their respective owners.

For price, delivery, and to place orders: Analog Devices, Inc., One Technology Way, P.O. Box 9106, Norwood, MA 02062-9106 Phone: 781-329-4700 • Order online at www.analog.com Application Support: Phone: 1-800-ANALOG-D



**GaAs InGaP HBT MMIC 1 WATT
POWER AMPLIFIER, 5.1 - 5.9 GHz**

Power Compression @ 5.8 GHz

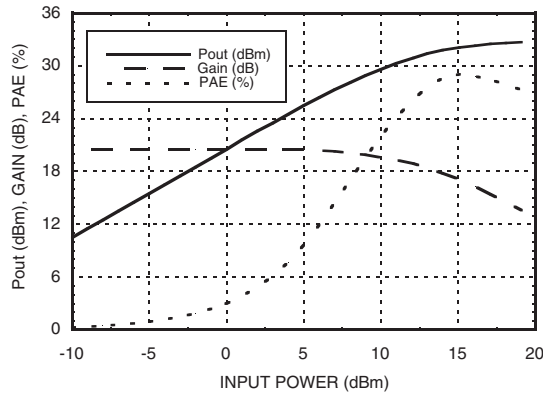

Output IP3 vs. Temperature

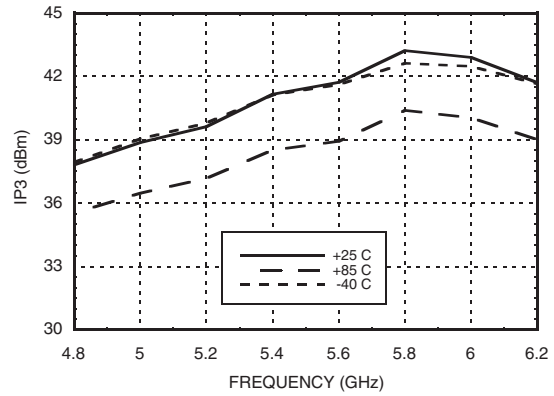

Noise Figure vs. Temperature

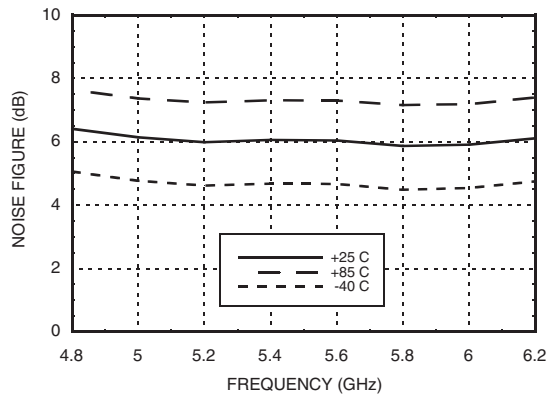

**Gain & Power vs.
Supply Voltage @ 5.8 GHz**

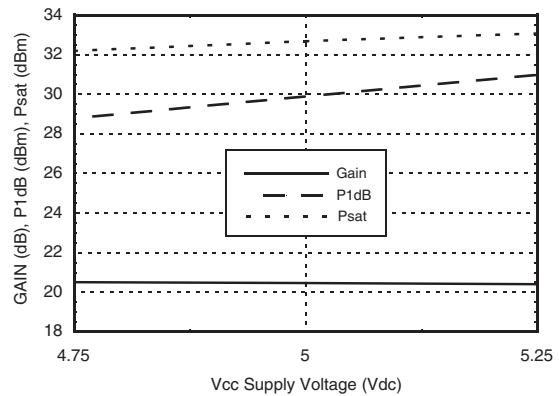

Reverse Isolation vs. Temperature

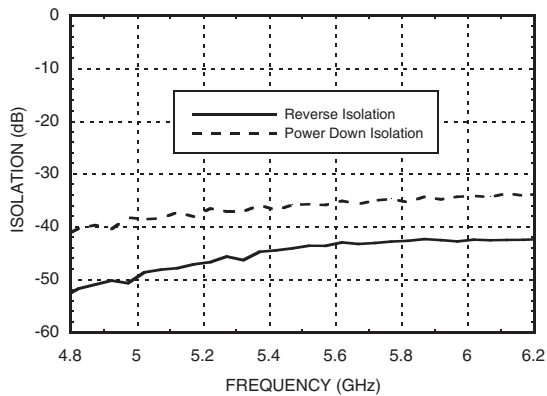

**Gain, Power & Quiescent
Supply Current vs. Vpd @ 5.8 GHz**

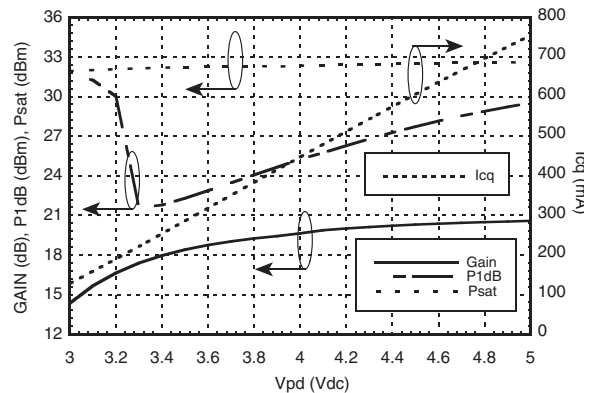

Information furnished by Analog Devices is believed to be accurate and reliable. However, no responsibility is assumed by Analog Devices for its use, nor for any infringements of patents or other rights of third parties that may result from its use. Specifications subject to change without notice. No license is granted by implication or otherwise under any patent or patent rights of Analog Devices. Trademarks and registered trademarks are the property of their respective owners.

For price, delivery, and to place orders: Analog Devices, Inc., One Technology Way, P.O. Box 9106, Norwood, MA 02062-9106 Phone: 781-329-4700 • Order online at www.analog.com Application Support: Phone: 1-800-ANALOG-D



GaAs InGaP HBT MMIC 1 WATT POWER AMPLIFIER, 5.1 - 5.9 GHz

Typical Supply Current vs. $V_s = V_{cc1} + V_{cc2}$

Absolute Maximum Ratings

| | |
|---|----------------|
| Collector Bias Voltage (V_{cc1}, V_{cc2}) | +5.5 Vdc |
| Control Voltage (V_{pd}) | +5.5 Vdc |
| RF Input Power (RFIN)($V_s = V_{pd} = +5V_{dc}$) | +20 dBm |
| Junction Temperature | 150 °C |
| Continuous P_{diss} ($T = 85$ °C) (derate 72.5 mW/°C above 85 °C) | 4.71 W |
| Thermal Resistance (junction to ground paddle) | 13.8 °C/W |
| Storage Temperature | -65 to +150 °C |
| Operating Temperature | -40 to +85 °C |

| V_s (V) | I_{cq} (mA) |
|-----------|---------------|
| 4.75 | 725 |
| 5.0 | 750 |
| 5.25 | 780 |

Note: Amplifier will operate over full voltage range shown above



ELECTROSTATIC SENSITIVE DEVICE
OBSERVE HANDLING PRECAUTIONS

11

Outline Drawing

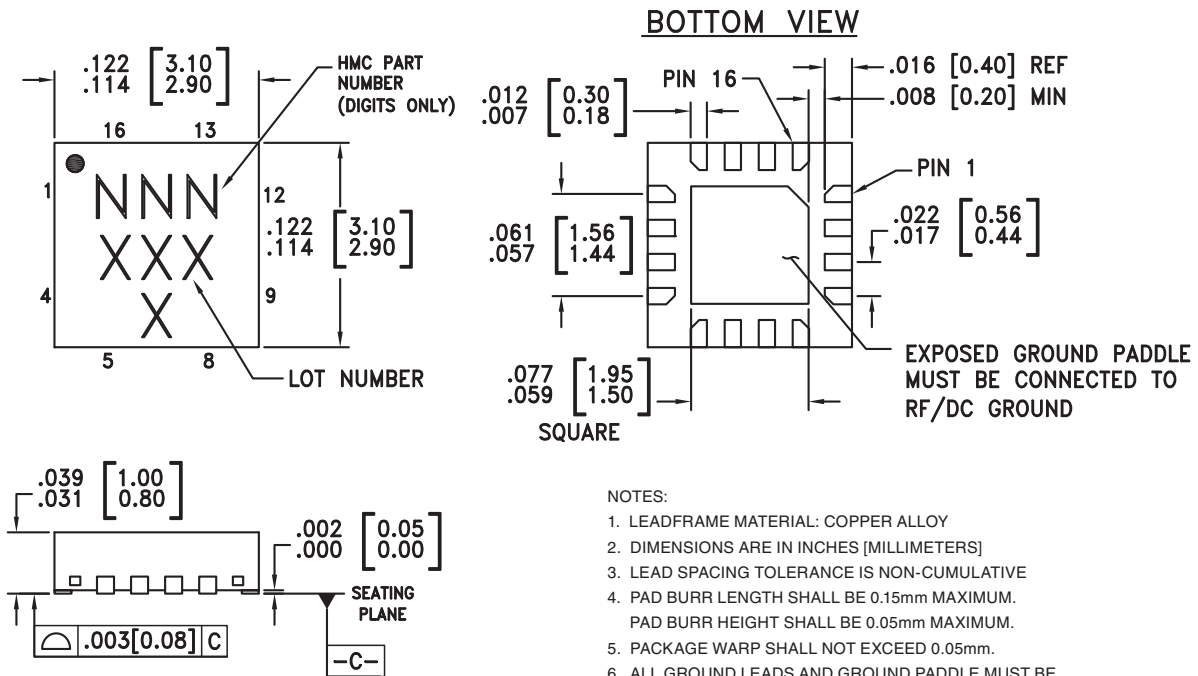

NOTES:

- LEADFRAME MATERIAL: COPPER ALLOY
- DIMENSIONS ARE IN INCHES [MILLIMETERS]
- LEAD SPACING TOLERANCE IS NON-CUMULATIVE
- PAD BURR LENGTH SHALL BE 0.15mm MAXIMUM.
PAD BURR HEIGHT SHALL BE 0.05mm MAXIMUM.
- PACKAGE WARP SHALL NOT EXCEED 0.05mm.
- ALL GROUND LEADS AND GROUND PADDLE MUST BE SOLDERED TO PCB RF GROUND.
- REFER TO HITTITE APPLICATION NOTE FOR SUGGESTED LAND PATTERN.

Package Information

| Part Number | Package Body Material | Lead Finish | MSL Rating | Package Marking ^[3] |
|-------------|--|---------------|---------------------|--------------------------------|
| HMC408LP3 | Low Stress Injection Molded Plastic | Sn/Pb Solder | MSL1 ^[1] | 408 XXXX |
| HMC408LP3E | RoHS-compliant Low Stress Injection Molded Plastic | 100% matte Sn | MSL1 ^[2] | 408 XXXX |

[1] Max peak reflow temperature of 235 °C



[2] Max peak reflow temperature of 260 °C

[3] 4-Digit lot number XXXX

GaAs InGaP HBT MMIC 1 WATT POWER AMPLIFIER, 5.1 - 5.9 GHz

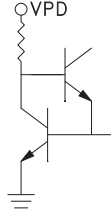
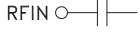
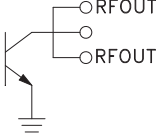
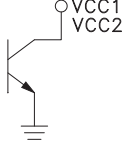

Pin Descriptions

| Pin Number | Function | Description | Interface Schematic |
|-------------------------|----------|---|---|
| 1 | Vpd | Power control pin. For maximum power, this pin should be connected to 5V. A higher voltage is not recommended. For lower idle current, this voltage can be reduced. |  |
| 2, 4, 5 - 8, 12, 13, 15 | N/C | No Connection | |
| 3 | RFIN | This pin AC coupled and matched to 50 Ohms. |  |
| 9, 10, 11 | RFOUT | RF output and DC bias for the output stage. |  |
| 14 | Vcc2 | Power supply voltage for the second amplifier stage. External bypass capacitors and pull up choke are required as shown in the application schematic. |  |
| 16 | Vcc1 | Power supply voltage for the first amplifier stage. External bypass capacitors are required as shown in the application schematic. | |
| | GND | Ground: Backside of package has exposed metal ground slug that must be connected to ground thru a short path. Vias under the device are required. |  |

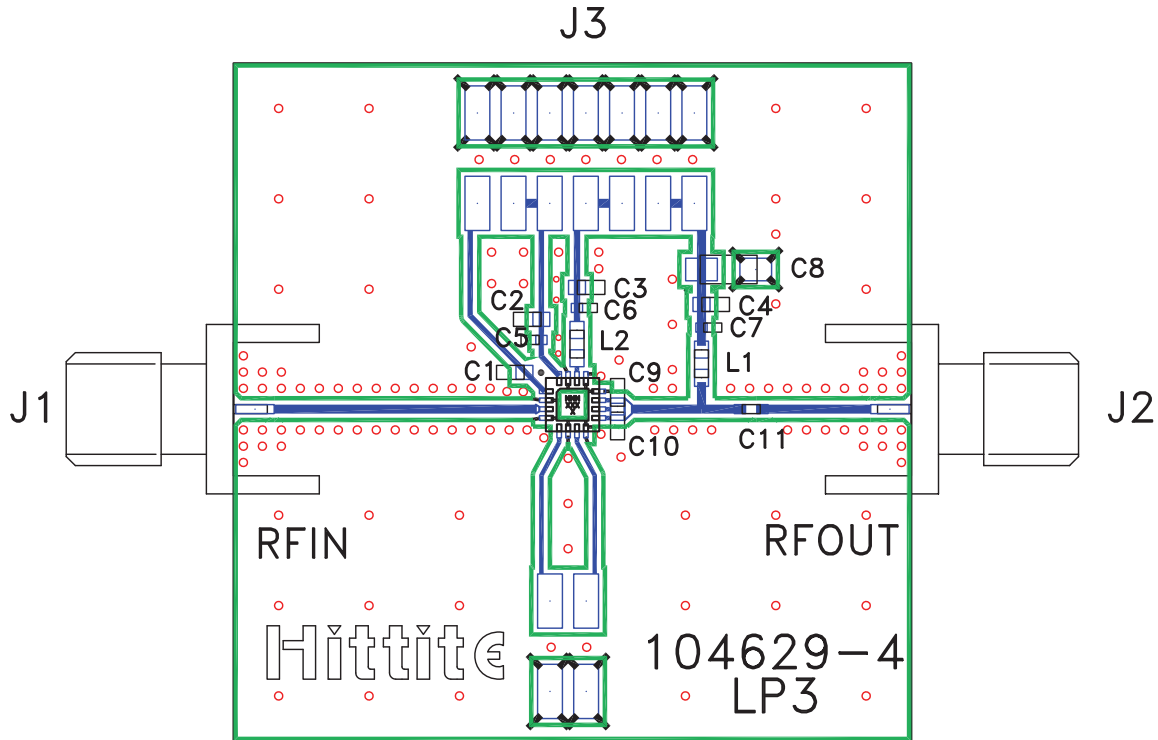
Evaluation PCB

List of Materials for Evaluation PCB 105180 [1]

| Item | Description |
|----------|----------------------------------|
| J1 - J2 | PCB Mount SMA RF Connector |
| J3 | 2 mm DC Header |
| C1 - C4 | 1,000 pF Capacitor, 0603 Pkg. |
| C5 - C7 | 100 pF Capacitor, 0402 Pkg. |
| C8 | 2.2 μ F Tantalum Capacitor |
| C9 - C10 | 0.5 pF Capacitor, 0603 Pkg. |
| C11 | 10 pF Capacitor, 0402 Pkg. |
| L1 - L2 | 1.6 nH Inductor, 0603 Pkg. |
| U1 | HMC408LP3 / HMC408LP3E Amplifier |
| PCB [2] | 104629 Eval Board |

[1] Reference this number when ordering complete evaluation PCB

[2] Circuit Board Material: Rogers 4350

The circuit board used in the final application should use RF circuit design techniques. Signal lines should have 50 ohm impedance while the package ground leads and exposed paddle should be connected directly to the ground plane similar to that shown. A sufficient number of via holes should be used to connect the top and bottom ground planes. The evaluation board should be mounted to an appropriate heat sink. The evaluation circuit board shown is available from Hittite upon request.



Application Circuit

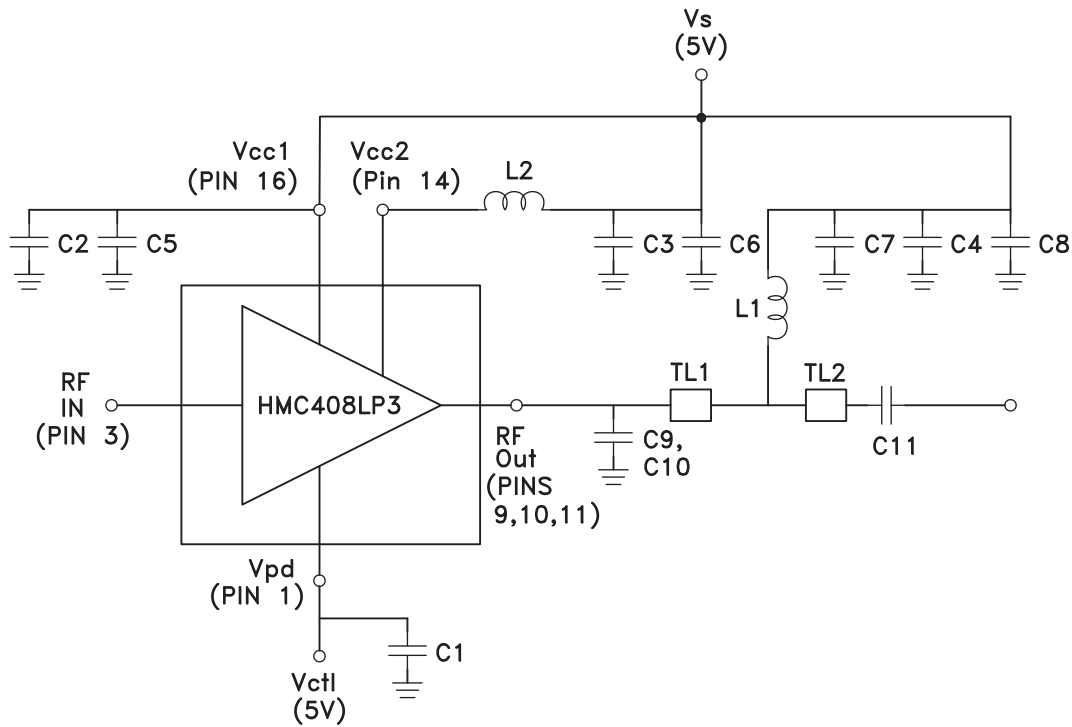

| Recommended Component Values | |
|------------------------------|----------|
| L1, L2 | 1.6 nH |
| C1 - C4 | 1,000 pF |
| C5 - C7 | 100 pF |
| C8 | 2.2 μF |
| C9 - C10 | 0.5 pF |

| | TL1 | TL2 |
|-----------|--------|--------|
| Impedance | 50 Ohm | 50 Ohm |
| Length | 0.200" | 0.100" |

Note 1: C9, C10 should be located < 0.020" from pins 9, 10, & 11.

Note 2: Application circuit values shown are optimized for 5.7 - 5.9 GHz operation.

Contact our Applications Engineers for optimization of output match for other frequencies.



Notes:

HMC408LP3 / 408LP3E

v03.0705

**GaAs InGaP HBT MMIC 1 WATT
POWER AMPLIFIER, 5.1 - 5.9 GHz**

11

LINEAR & POWER AMPLIFIERS - SMT

Information furnished by Analog Devices is believed to be accurate and reliable. However, no responsibility is assumed by Analog Devices for its use, nor for any infringements of patents or other rights of third parties that may result from its use. Specifications subject to change without notice. No license is granted by implication or otherwise under any patent or patent rights of Analog Devices. Trademarks and registered trademarks are the property of their respective owners.

For price, delivery, and to place orders: Analog Devices, Inc.,
One Technology Way, P.O. Box 9106, Norwood, MA 02062-9106
Phone: 781-329-4700 • Order online at www.analog.com
Application Support: Phone: 1-800-ANALOG-D